

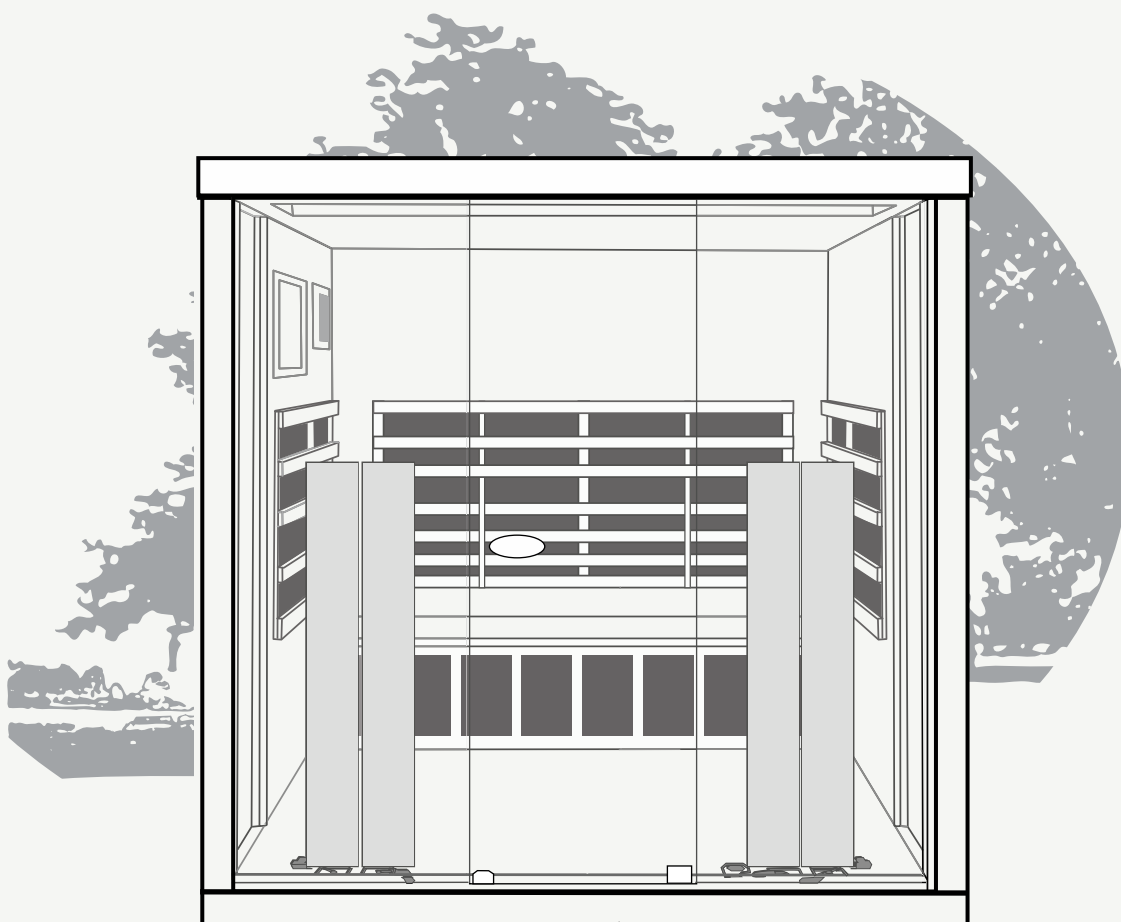

Owner's Manual



Jacuzzi® Full Spectrum Infrared Saunas

Please read this manual before using your Sauna for the first time.
Please keep this manual for future reference.

Table of Contents

Installation	04
01 Jacuzzi® JS-1i and JS-2i	05
Packaging	06
Assembly Instructions	07
02 Jacuzzi® JS-3i	20
Packaging	21
Assembly Instructions	22
Enjoying Your Sauna	35
Using Your Sauna Control Panel	36
Tips for Use	40
Safety Instructions	42
Important Safeguards	44

* The information contained in this manual is subject to change without notice.

Installation

Choosing a Location

Place your sauna on a dry and level surface for best results.

Installation requirements for your sauna are as follows:

1. Your Jacuzzi® sauna is a self-contained and freestanding unit. It should not be built into any structure without prior authorization.
2. Please maintain a minimum of 4-inch clearance on all sides of the unit to allow air to circulate while giving access for the power cord.

Cleaning and Maintenance

1. Before using your sauna for the first time, clean the inside of the sauna with a damp cloth.
2. Place a towel on the floor and bench to absorb any perspiration. Wash these often to maintain a clean and pleasant environment inside your sauna.
3. Perspiration may darken the wood over time. Refer to Varnish Instructions.



Please be careful when carrying and installing the glass pieces to avoid breakage. Make certain the glass is securely fastened during installation before letting go of any individual piece that could break.

01

Jacuzzi® Saunas JS-1i and JS-2i

Packaging - - - - -	06
Assembly Instructions - - - - -	07

Packaging

Contents of Boxes

Box 1 of 6

Roof and Floor Panels
Installation Manual

Box 2 of 6

Left Side Wall
Right Side Wall

Box 3 of 6

Front Wall
Back Wall

Box 4 of 6

Metal Threaded Rods

Box 5 of 6

Parts and Accessories
Right Side Wall

Box 6 of 6

2 x Full Spectrum
Heaters

Accessory Box Contents

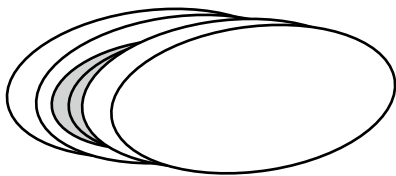

Door Handle

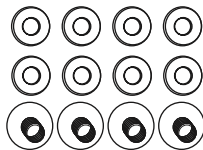

Front Heater
Mounting Screws
(4 sets)

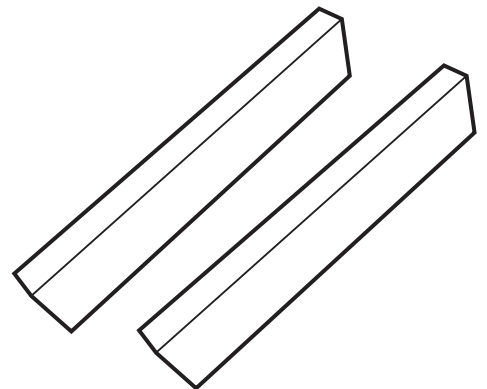

Wood piece
(2 pieces)

Assembly Instructions

Assembly of the sauna requires a minimum of two adults to complete. As noted, a third person is recommended when installing the glass components. Please read the instructions thoroughly before and during assembly to ensure proper installation of the unit. Wearing booties to cover your shoes will protect the wood from getting scuffed or stained.

1 - Location of Sauna and Installation Order

When determining a location for your sauna, please keep in mind the following:

1. The main power cord on the sauna must be easily accessible.
2. The location must be dry and level.
3. Panels should be installed in the following order:

1) Floor	4) Right Side Wall	7) Roof
2) Back Wall	5) Under Bench Support	8) Front Wall Glass

2 - Placing Floor Panel

1. Place the bottom floor panel on the ground near the location you will be using the sauna. Make sure the front of the floor is in the desired location of the door. The metal threshold indicates the front of the sauna.

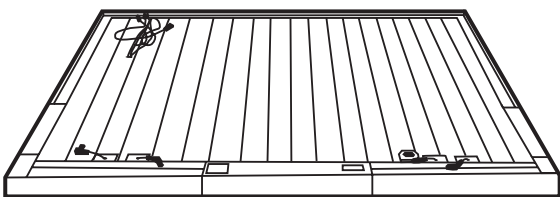

3 - Connecting the Back Panel to the Floor Panel

1. Connect the back panel to the floor panel by lining up the back panel on the groove of the floor panel.

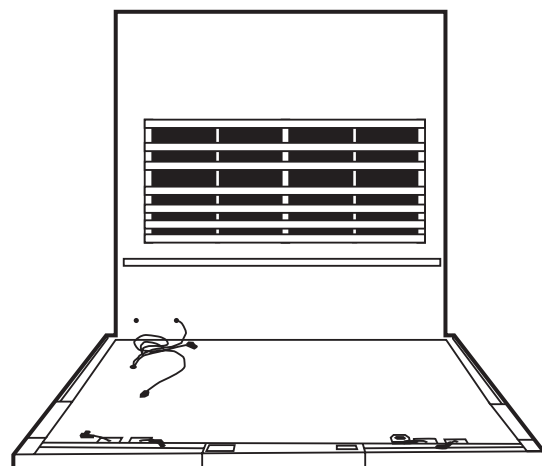

Assembly Instructions Cont'd

4 - Connecting Side Walls

1. Place the left side wall in the slot in the floor positioned as in the drawing below.
2. When the wall is in place, make sure the metal rod is positioned in the metal nut in the floor.
3. Screw the metal bolt from the top of the panel into the metal nut in the floor using your hand to twist the metal rod.
4. Repeat this step installing the Right Side Wall.

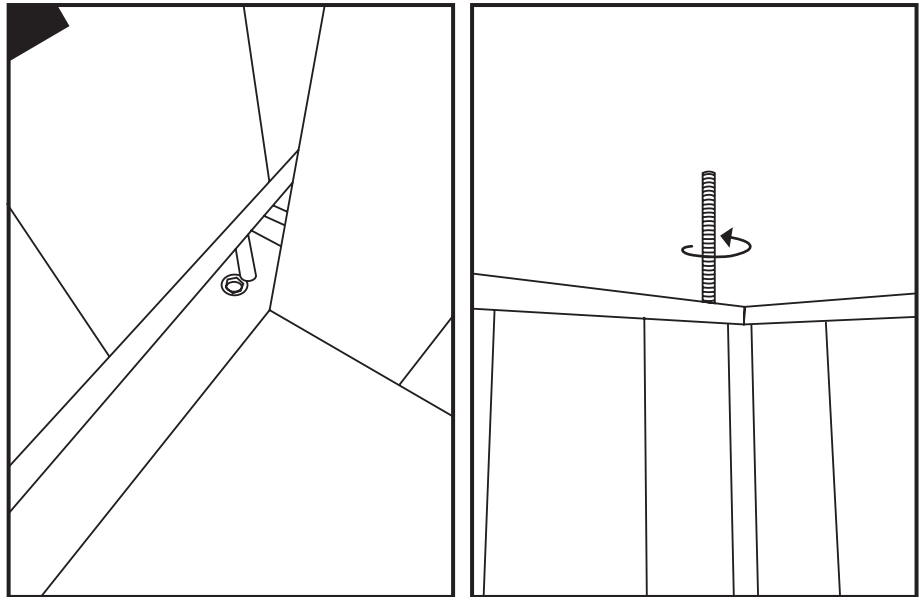

If the panels still seem too tight to come down all the way, try backing off the bracket screws by one half turn with a Phillips head screwdriver.

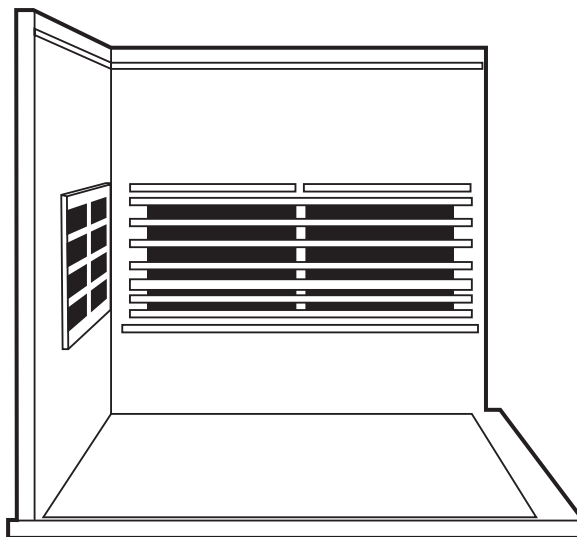

Left Side Wall Installed

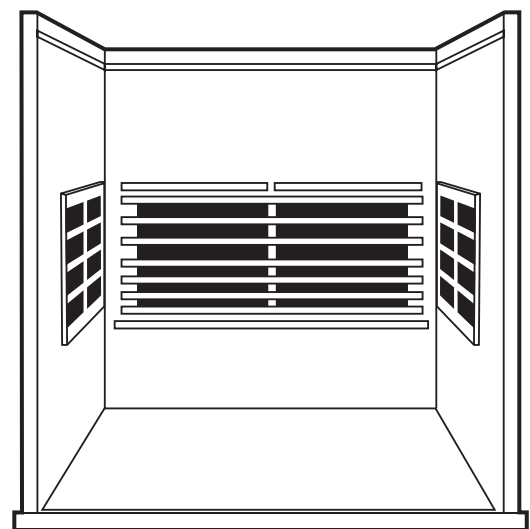

Right Side Wall Installed

Assembly Instructions Cont'd

5 - Installing Side Wall Glass

When installing the glass panels, a third person is recommended to support the glass during installation..

1. Insert the left side wall glass into the slot in the left side wall and make sure it's well seated on the floor.
2. Repeat this step with the Right Side glass.



Assembly Instructions Cont'd

6 - Install Front Columns

1. Located the two (2) front columns and the corresponding metal rods.

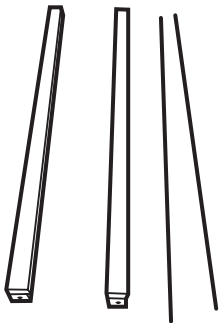

2. Thread the rods through the columns.



3. Align one of the threaded columns with the left side glass and position the metal rod over the metal nut in the floor.
4. Hand screw the metal rod into the nut until it is tight.
5. Repeat this step for the Right Side Column.



Note: Some of the rod will be exposed at the top of the column.

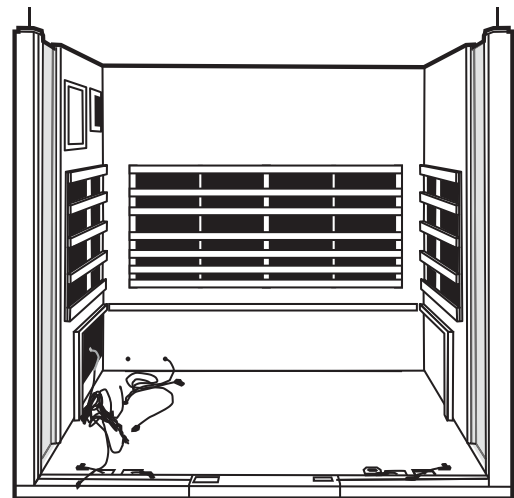

Assembly Instructions Cont'd

7 - Installing Under Bench Support

Slide down the bench heater panel by lining up its sides with the vertical guides on the left and right side wall panel.

1. Be careful not to scratch the side panels when positioning the heater panel.
2. Push the bench heater panel all the way down until it is touching the floor panel and securely in place.

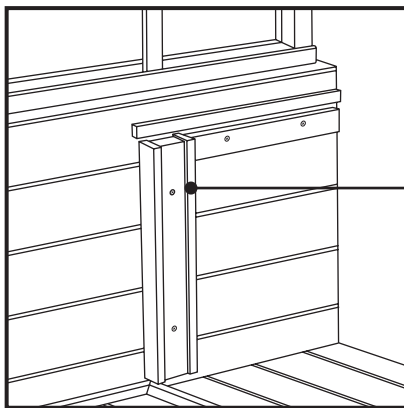

Vertical bench heater panel guides are found on the side panels.

Heater must be facing outward

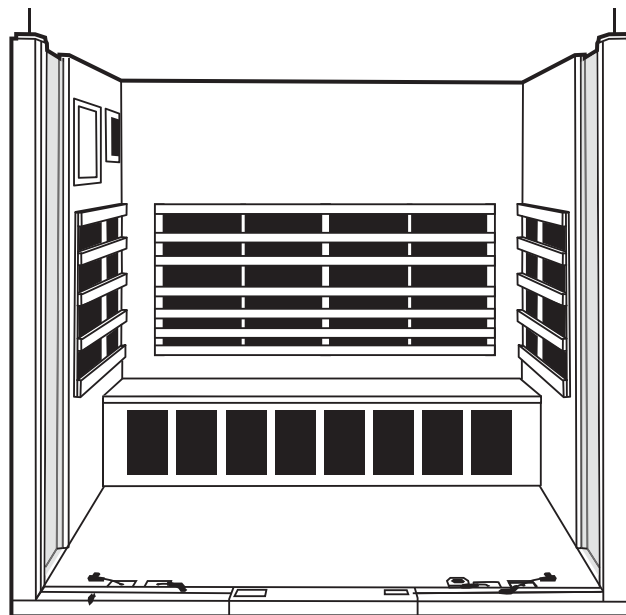
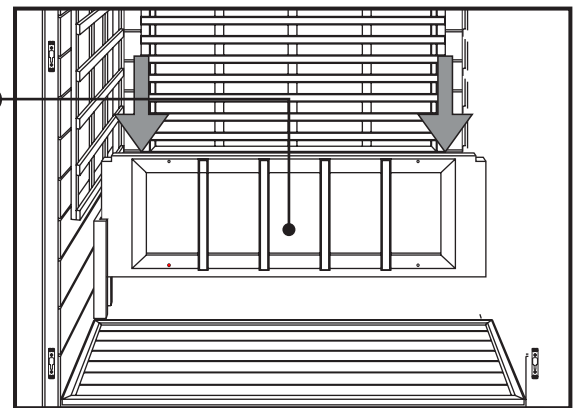

Assembly Instructions Cont'd

8 - Connect Heater Connection Under Bench

1. Locate the power supply on the left side wall.
2. The outlets in the power supply are numbered. Match the six (6) numbered black IEC plugs with the numbered outlets and plug them in. Make sure they are well seated.
3. Plug the cable with the Blue/Red/Green wires and molex connector into the receptacle in the power supply.
4. Locate the wood power supply guard.
5. Place it over the power supply and screw it in place.

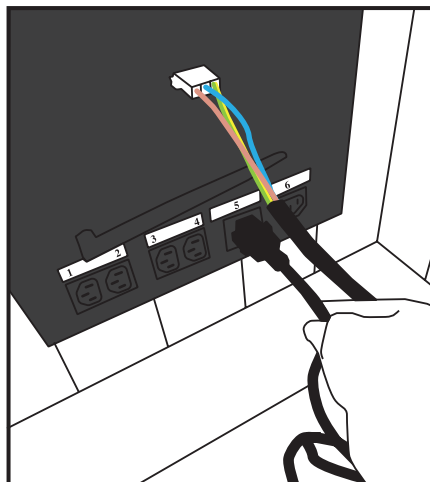
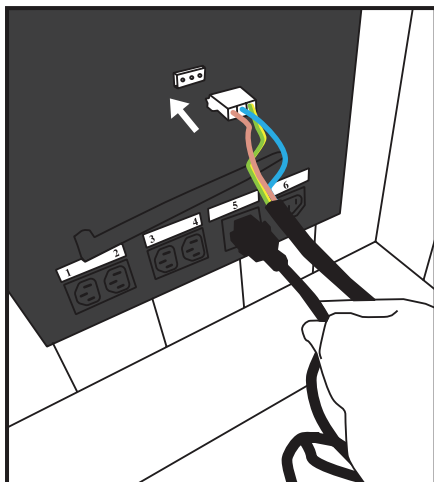
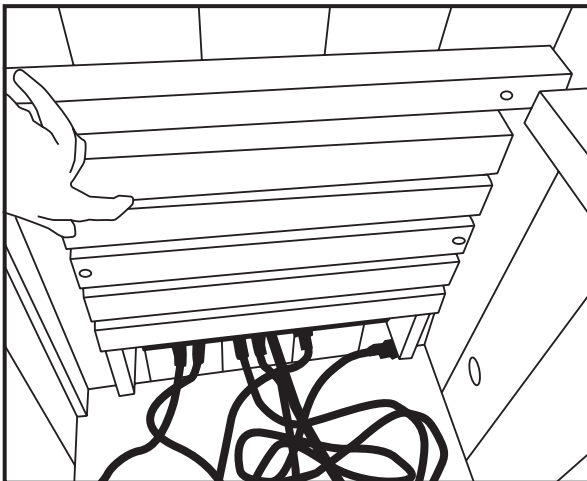

Assembly Instructions Cont'd

9 - Installing the Bench

Install the bench panel by sliding it over the horizontal bench guides on the side panels. Be careful not to scratch the adjacent panels when sliding in the bench.

Push the bench all the way in until it touches the back panel and is securely in place.

Be sure that the bench is pushed all the way back until it slides under the heater guard to secure the bench in place.

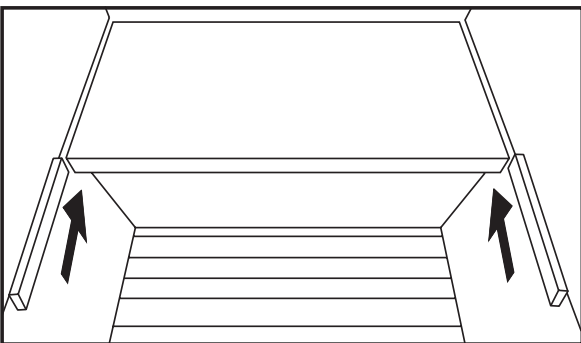
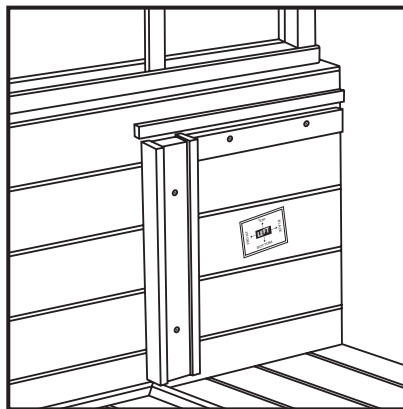
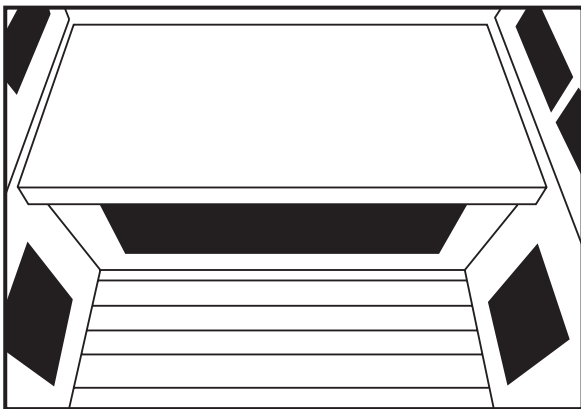

After the bench is installed, slide in the included wood pieces to prevent the bench from sliding left to right. One piece can be placed on each side next to the bench.

Assembly Instructions Cont'd

10 - Installing the Roof

1. Locate the roof.
2. Lift the roof over the exposed metal rods and align the holes in the roof over the metal rods.
3. Lower the roof down onto the walls and front columns.

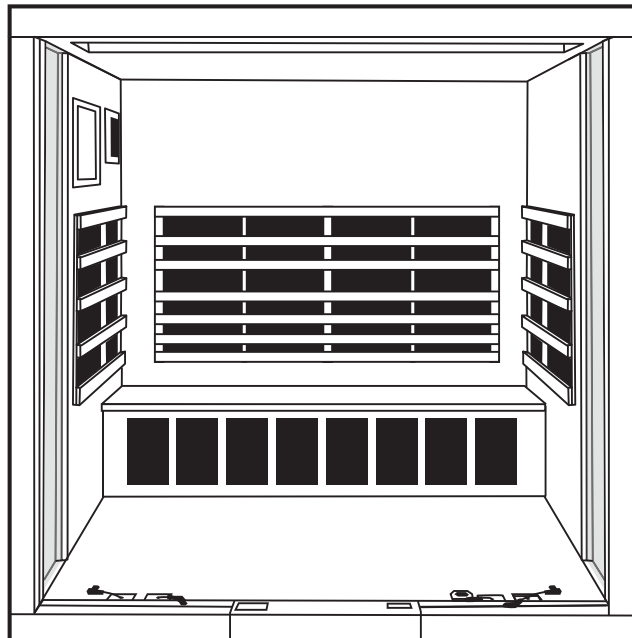

Assembly Instructions Cont'd

11 - Installing Left and Right Side Glass Window

1. Locate the Left Front Glass.
2. Lift up the roof an inch and position the left front glass in place sliding it into the left front column.
3. Seat the roof on the glass making sure the glass is in the slot in the roof.

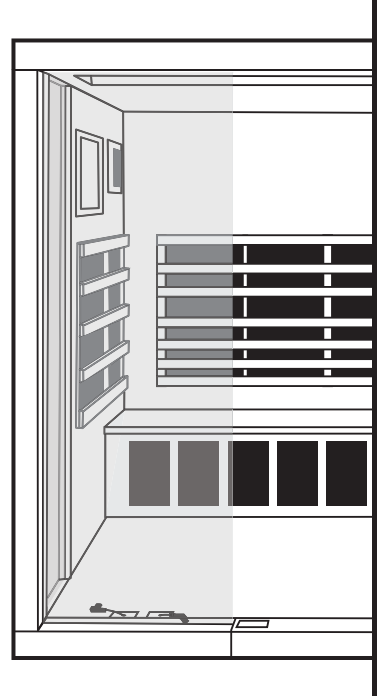

4. Repeat this step for the Right Front Glass.



Assembly Instructions Cont'd

12 - Installing Door Handle

1. Locate the door handle.
2. Attach the door handle using the enclosed screws.

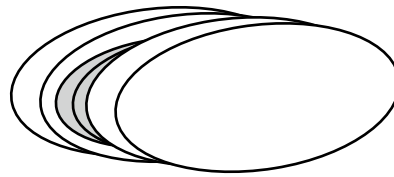

Note: If you are using a tablet or smartphone to control your sauna, the door handle will act as both the door handle and tablet/smartphone holder when the door is closed.

13 - Installing Front Heaters

1. Locate the two (2) front heaters.
2. Align the left front heaters and plug the connector that comes out of the bottom of the heaters into the plug coming out of the in the floor.
3. Align the the hole in the back of the heater with the hole in the front wall glass. Using the included screws and washers, secure the heater to the glass through the pre-drilled hole. One washer will be placed on the inside and one on the outside glass. The heater will be secured with these screws in two locations.
4. Be sure to tuck the cable into the bottom of the heater so it is hidden and will not be damaged.

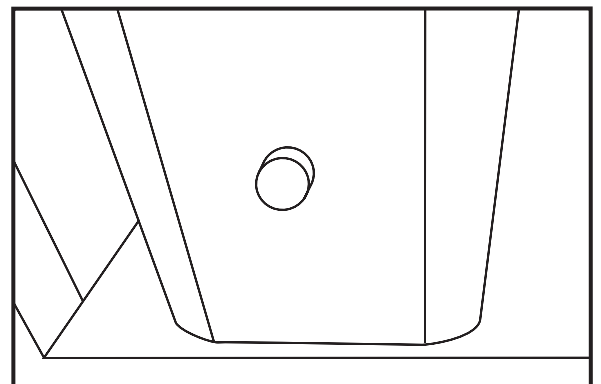
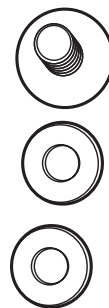
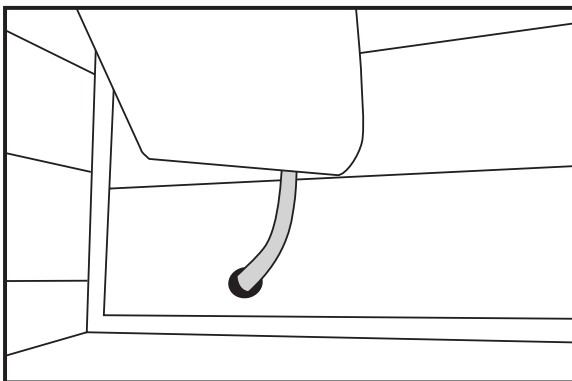

Assembly Instructions Cont'd

14 - Installing Front Heaters

4. Repeat this step for the right front heaters.

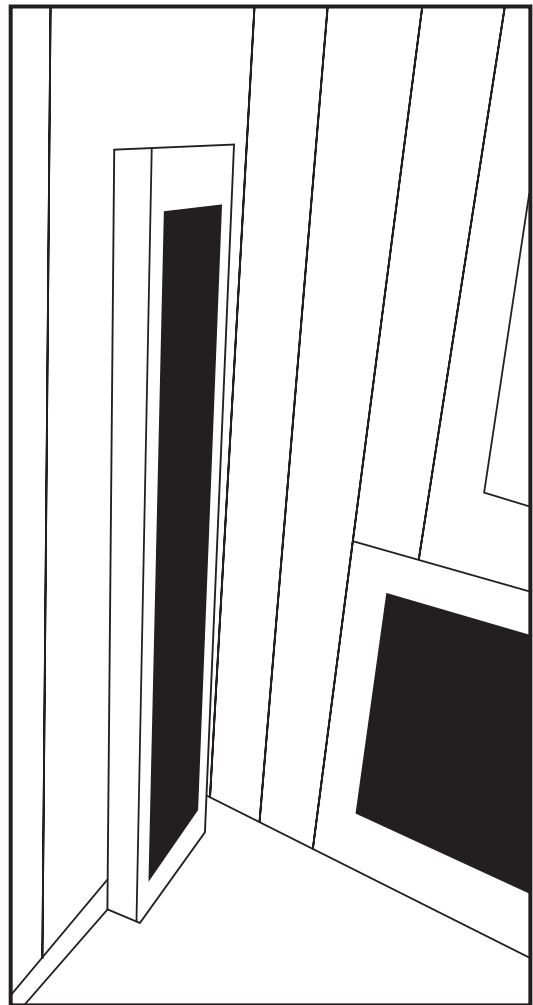

Front Heater Installed



Warning Notice

The infrared heaters in your sauna are a potential BURN HAZARD. DO NOT TOUCH the infrared heaters when they are in operation and allow to cool before servicing.

Assembly Instructions Cont'd

15 - Locating and plugging in power cord

The power cord comes out of the back wall of the sauna at the left facing back corner about 6" from the floor. The power cord must be plugged into the appropriate grounded outlet.



Note: We do not recommend using an extension cord for your sauna. Please plug the sauna directly into the wall receptacle.

Assembly Instructions Cont'd

16 - Installation is Complete

Installation of your sauna is now complete. Using a damp cloth, wipe out the sauna to remove any excess saw dust that may have settled on the wall & floor panels and the heater panels during manufacturing and shipping.

Please refer to usage instructions located later on in this manual.

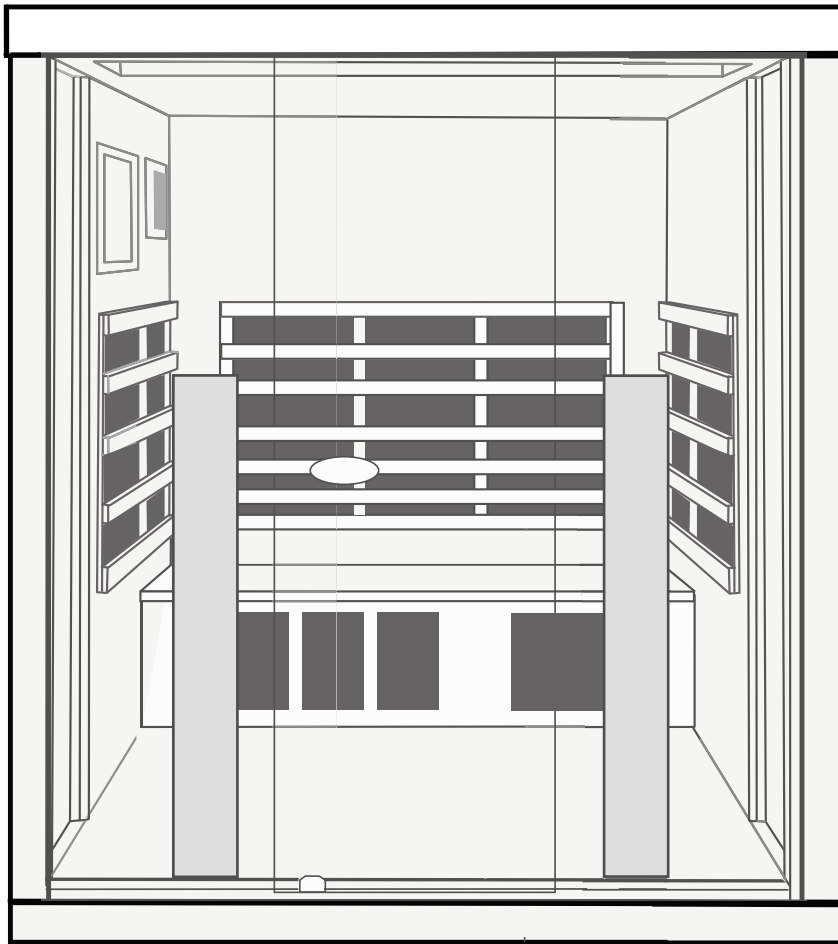

02

Jacuzzi® Saunas JS-3i

Packaging - - - - -	21
Assembly Instructions - - - - -	22

Packaging

Contents of Boxes

Box 1 of 7

Roof and Floor Panels
Installation Manual

Box 2 of 7

Left Side Wall
Right Side Wall

Box 3 of 7

Front Wall
Back Wall

Box 4 of 7

Metal Threaded Rods

Box 5 of 7

Parts and Accessories
Right Side Wall

Box 6 of 7

2 x Full Spectrum
Heaters

Box 7 of 7

2 x Full Spectrum
Heaters

Accessory Box Contents

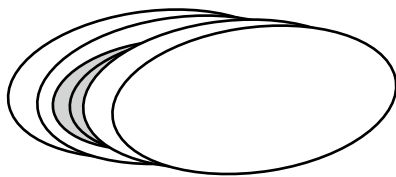

Door Handle

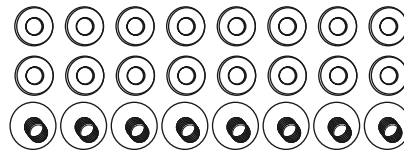

Front Heater
Mounting Screws
(8 sets)

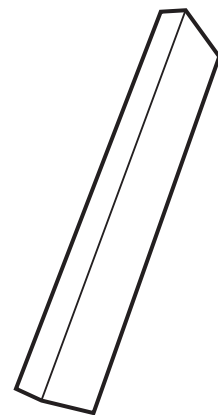

Wood piece
(2 pieces)

Assembly Instructions Cont'd

Assembly of the sauna requires a minimum of two adults to complete. As noted, a third person is recommended when installing the glass components. Please read the instructions thoroughly before and during assembly to ensure proper installation of the unit. Wearing booties to cover your shoes will protect the wood from getting scuffed or stained

1 - Location of Sauna and Installation Order

When determining a location for your sauna, please keep in mind the following:

1. The main power cord on the sauna must be easily accessible.
2. The location must be dry and level.
3. Panels should be installed in the following order:

1) Floor	4) Right Side Wall	7) Roof
2) Back Wall	5) Under Bench Support	8) Front Wall Glass
3) Left Side Wall	6) Bench	

2 - Placing Floor Panel

1. Place the bottom floor panel on the ground near the location you will using the sauna. Make sure the front of the floor is in the desired location of the door. The metal threshold indicates the front of the sauna.

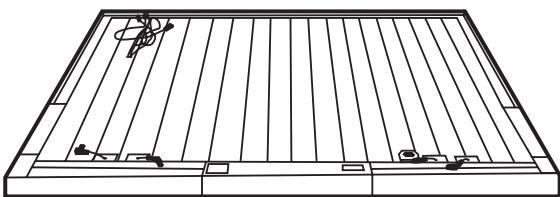

3 - Connecting the Back Panel to the Floor Panel

1. Connect the back panel to the floor panel by lining up the back panel on the groove of the floor panel.

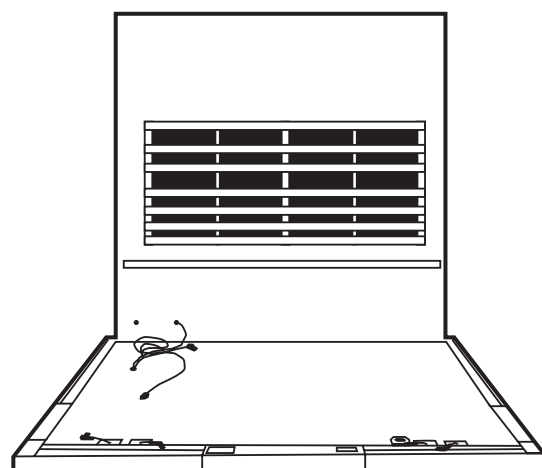

Assembly Instructions Cont'd

4 - Connecting Side Panels

1. Please the left side wall in the slot in the floor positioned as in the drawing below.
2. When the wall is in place, make sure the metal rod is positioned in the metal nut in the floor.
3. Screw the metal bolt from the top of the panel into the metal nut in the floor using your hand to twist the metal rod.
4. Repeat this step installing the Right Side Wall.

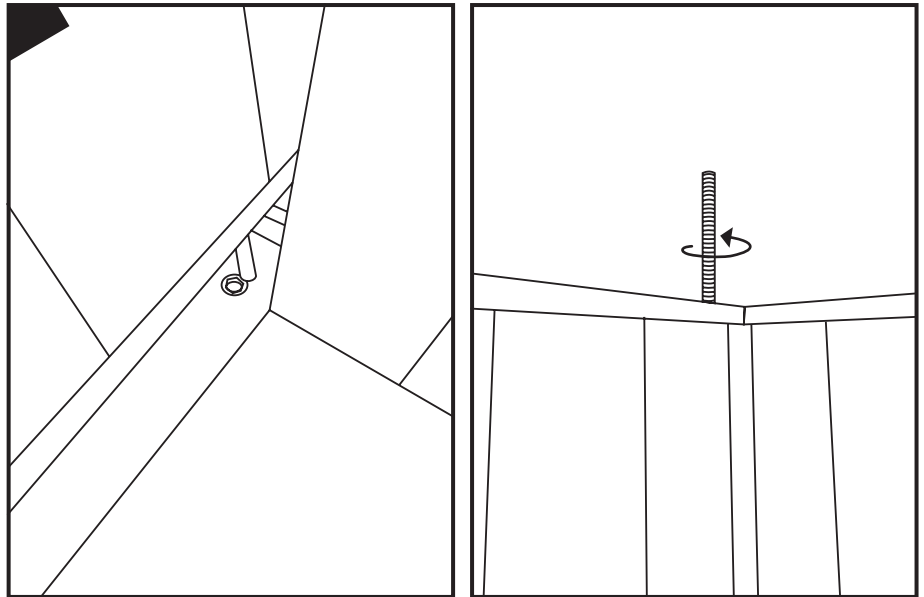

If the panels still seem too tight to come down all the way, try backing off the bracket screws by one half turn with a Phillips head screwdriver.

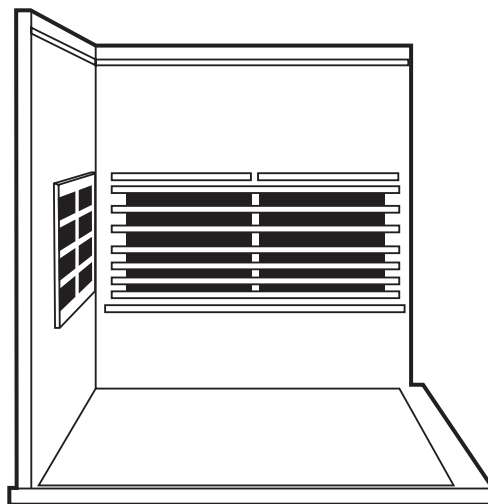

Left Side Wall Installed

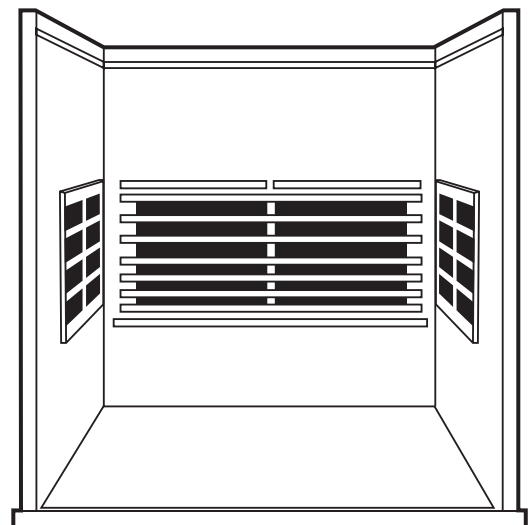

Right Side Wall Installed

Assembly Instructions Cont'd

5 - Installing Side Wall Glass

Assembly of the sauna requires two adults to complete.

Please read the instructions thoroughly before and during assembly to ensure proper installation of the unit.

1. Insert the left side wall glass into the slot in the left side wall and make sure it's well seated on the floor.
2. Repeat this step with the Right Side glass.



Assembly Instructions Cont'd

6 - Install Front Columns

1. Locate the two (2) front columns and the corresponding metal rods.

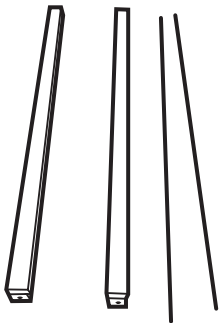

2. Thread the rods through the columns.



3. Align one of the threaded columns with the left side glass and position the metal rod over the metal nut in the floor.
4. Hand screw the metal rod into the nut until it is tight.
5. Repeat this step for the Right Side Column.



Note: Some of the rod will be exposed at the top of the column.

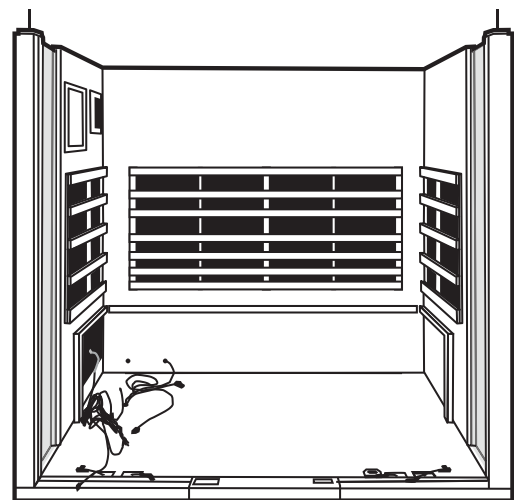

Assembly Instructions Cont'd

7 - Installing Under Bench Support

Slide down the bench heater panel by lining up its sides with the vertical guides on the left and right side wall panel.

1. Be careful not to scratch the side panels when positioning the heater panel.
2. Push the bench heater panel all the way down until it is touching the floor panel and securely in place.

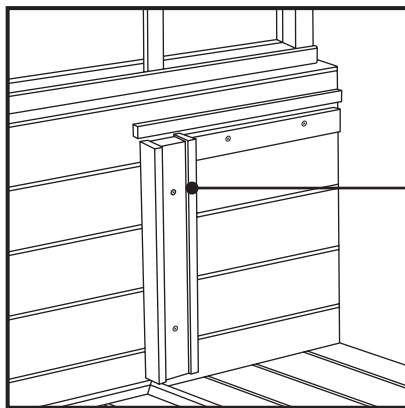

Heater must be facing outward

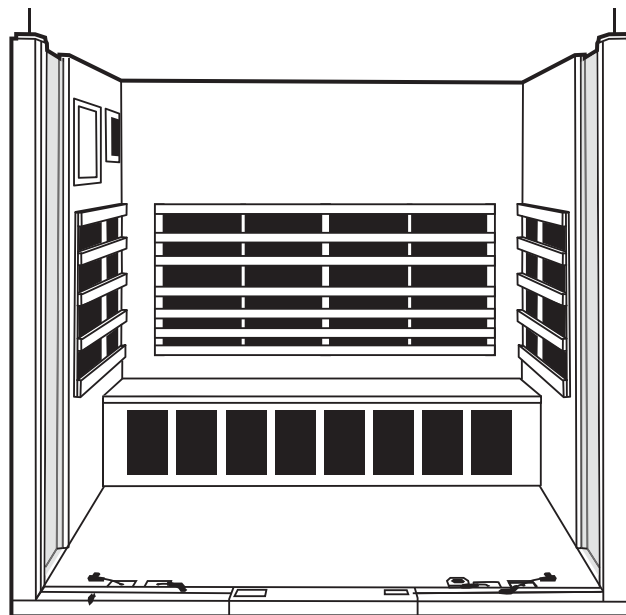
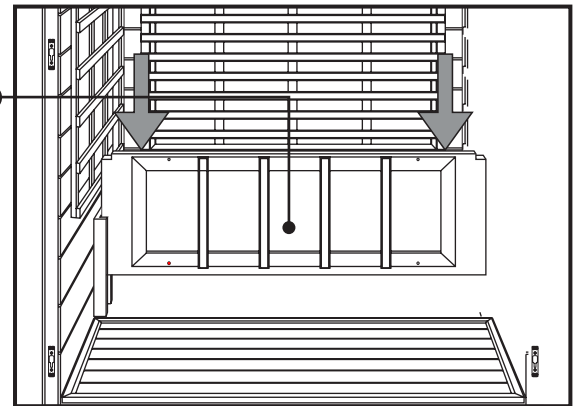

Assembly Instructions Cont'd

8 - Connect Heater Connection Under Bench

1. Locate the power supply on the left side wall.
2. The outlets in the power supply are numbered. Match the six (6) numbered black IEC plugs with the numbered outlets and plug them in. Make sure they are well seated.
3. Plug the cable with the Blue/Red/Green wires and molex connector into the receptacle in the power supply.
4. Locate the wood power supply guard.
5. Place it over the power supply and screw it in place.

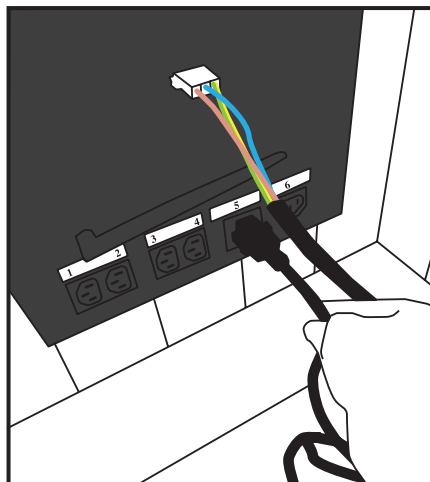
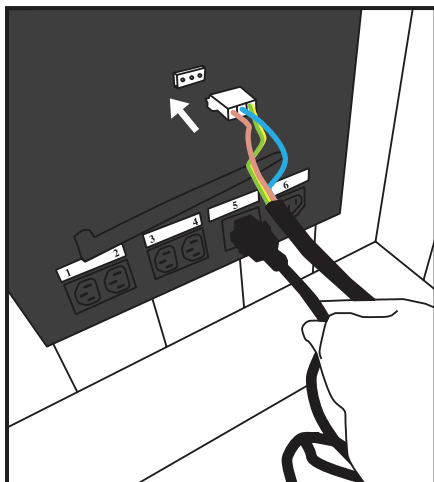
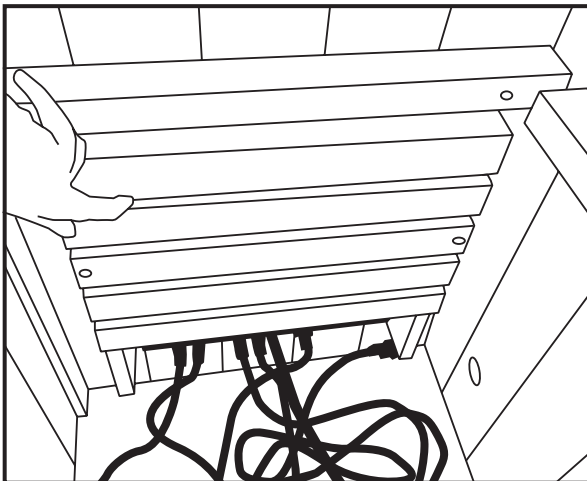

Assembly Instructions Cont'd

9 - Installing the Bench

Install the bench panel by sliding it over the horizontal bench guides on the side panels. Be careful not to scratch the adjacent panels when sliding in the bench.

Push the bench all the way in until it touches the back panel and is securely in place.

Be sure that the bench is pushed all the way back until it slides under the heater guard to secure the bench in place.

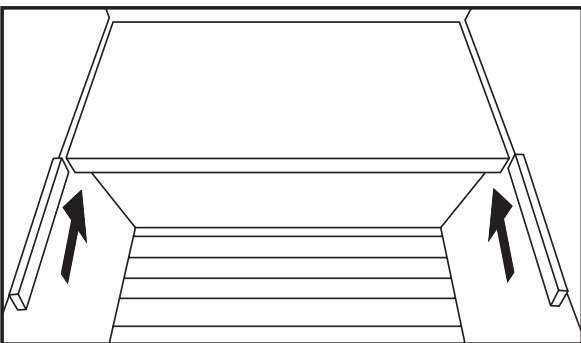
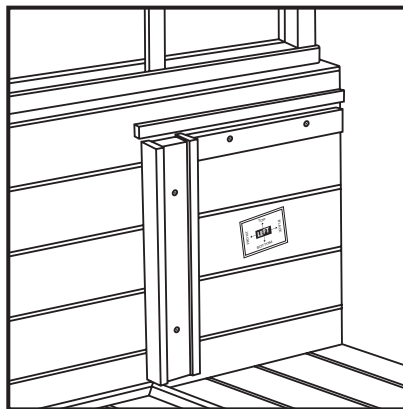
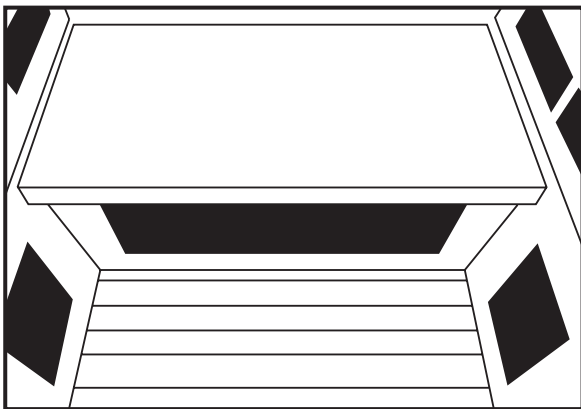

After the bench is installed, slide in the included wood pieces to prevent the bench from sliding left to right. One piece can be placed on each side next to the bench.

Assembly Instructions Cont'd

10 - Installing the Roof

1. Locate the roof.
2. Lift the roof over the exposed metal rods and align the holes in the roof over the metal rods.
3. Lower the roof down onto the walls and front columns.

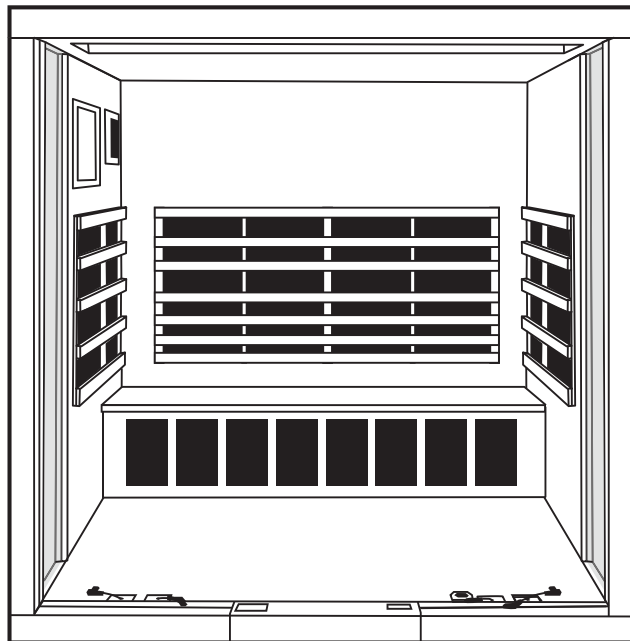

Assembly Instructions Cont'd

11 - Installing Left and Right Side Glass Window

When installing the glass panels, a third person is recommended to support the glass during installation.

1. Locate the Left Front Glass.
2. Lift up the roof an inch and position the left front glass in place sliding it into the left front column.
3. Seat the roof on the glass making sure the glass is in the slot in the roof.

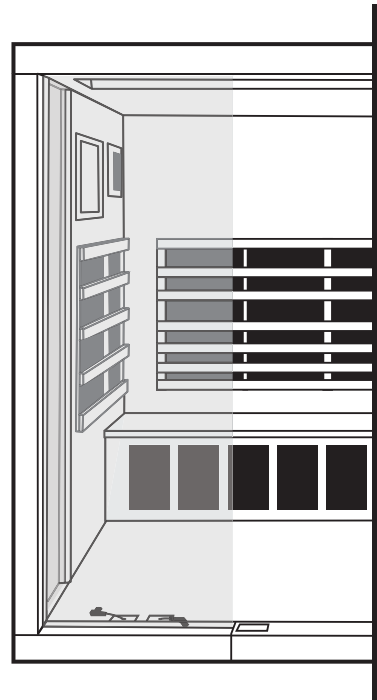

4. Repeat this step for the Right Front Glass.



Assembly Instructions Cont'd

12 - Installing Door Handle

1. Locate the door handle.
2. Attach the door handle using the enclosed screws.

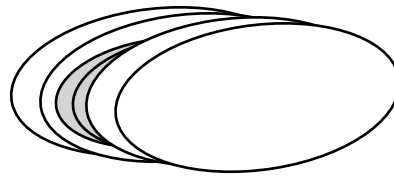

Note: If you are using a tablet or smartphone to control your sauna, the door handle will act as both the door handle and tablet/smartphone holder when the door is closed.

13- Installing Front Heaters

1. Locate the four (4) front heaters.
2. Align the left front heaters and plug the connector that comes out of the bottom of the heaters into the plug coming out of the in the floor.
3. Align the the hole in the back of the heater with the hole in the front wall glass. Using the included screws and washers, secure the heater to the glass through the pre-drilled hole. One washer will be placed on the inside and one on the outside glass. The heater will be secured with these screws in two locations.
4. Be sure to tuck the cable into the bottom of the heater so it is hidden and will not be damaged.

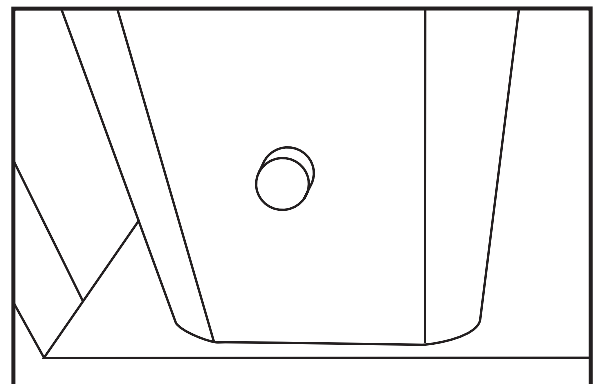
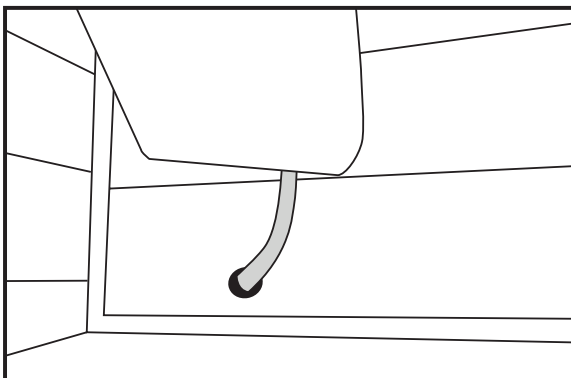

Assembly Instructions Cont'd

14 - Installing Front Heaters

4. Repeat this step for the right front heaters.



Front Heater Installed



Warning Notice

The infrared heaters in your sauna are a potential BURN HAZARD. DO NOT TOUCH the infrared heaters when they are in operation and allow to cool before servicing.

Assembly Instructions Cont'd

15 - Locating and plugging in power cord

The power cord comes out of the back wall of the sauna at the left facing back corner about 6" from the floor. The power cord must be plugged into the appropriate grounded outlet.



Note: We do not recommend using an extension cord for your sauna. Please plug the sauna directly into the wall receptacle.

Assembly Instructions Cont'd

17 - Installation is Complete

Installation of your sauna is now complete. Using a damp cloth, wipe out the sauna to remove any excess saw dust that may have settled on the wall & floor panels and the heater panels during manufacturing and shipping.

Please refer to usage instructions located later on in this manual.

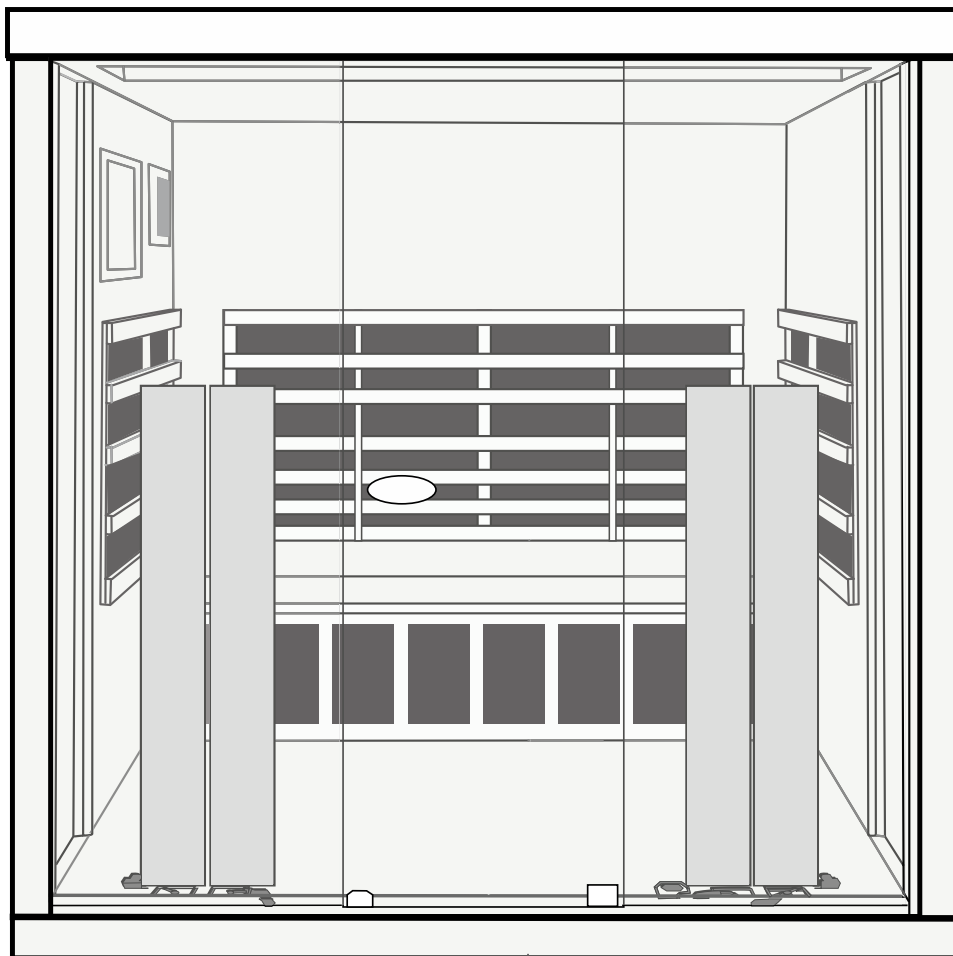

Enjoying Your Sauna

Enjoy Your Sauna

Your sauna is now ready for use and you are about to enjoy the wellness benefits found in an infrared sauna. Make sure you have a plenty of water to drink and enough towels.

Infrared heat works by warming your body directly without having to heat the air inside the sauna. Breathing is easier and healthier because the air temperature is not heated to the same degree as other types of saunas. The infrared heat penetrates deeply into your body to relax muscles sore from physical activity and help alleviate pain. The bench, walls and fixtures are not hot to the touch. This allows for a more enjoyable sauna session.

Instructions for Use

Review all health and safety instructions. If in doubt as to the advisability of using your infrared sauna, consult with your physician. If you feel light-headed or heat-exhausted during a session, exit the sauna immediately.

1. Select the desired session temperature and time using the control panel.
2. Allow approximately 10-15 minutes for the sauna to warm up before beginning a session.
3. Starting out, we recommend that your sauna session does not exceed 30 minutes.
4. When the temperature reaches the level set on the control panel, the heaters will turn off and on periodically in order to maintain the desired temperature level inside the sauna. Keeping the thermostat set at its maximum will ensure the heaters stay on continuously.
5. The ceiling vent(s) in the ceiling panel can be opened at any time to allow fresh air into the sauna.
6. Infrared's unique property of direct penetration into the body without heating the intervening space in-between allows the users to enjoy all of its benefits while the door is open for ventilation.
7. Always drink plenty of water before, during, and after a session. Doing so will replenish fluids lost from the body through perspiration.
8. To absorb perspiration and keep the sauna tidy during the session, place a towel on the bench and floor of the sauna. Keep one towel handy to wipe excessive perspiration from your body.

Using Your Sauna Control Panel

Using Your Infrared Sauna

Unlike a traditional sauna, infrared heats the body directly. Air temperature in the sauna is not as important as the type and quality of the infrared being received. We recommend the following protocol:

- a. Turn the sauna to allow the heaters to come up to optimal temperature and for the cabin to warm to a comfortable temperature.
- b. When you enter the sauna, set the time to the desired session time and turn the thermostat up to 150°F / 65°C. This will keep the heaters on the entire time to ensure that you are receiving constant infrared heat.
- c. Sit back and relax. Enjoy your sauna session.



When connected to the properly grounded power source, your Jacuzzi® sauna will turn ON to the set temperature and count-down with a few pushes of the Power button.



System On/Off

- 1) Press the “POWER” button once to turn on the sauna.
- 2) Your session will automatically end after the programmed timer expires.
- 3) Press the “POWER” button at any time turn off the sauna.



Sauna Session Time

You can set the duration of your sauna session for a maximum of 60 minutes. Press the TIME UP or TIME DOWN buttons to increase or decrease your desired sauna session time in 5 minute increments.

When you have reached your desired time, release the button.

Controlling the Set Temperature

You can program your sauna for a maximum temperature of 175°F (80°C). Press the TEMP UP/DOWN (+/-) buttons to set the desired temperature. When the display shows your desired temperature, release the buttons. Press either the TEMP UP or TEMP DOWN buttons during your sauna session to manually control the desired cabin temperature.

*See “Instructions For Use” on next page for recommendations.

Using Your Sauna Control Panel

Using Your Infrared Sauna



Fahrenheit & Celsius

You can alternate between Fahrenheit and Celsius by pressing the F/C button on the keypad. asdfdsa asdfas



Inside Light

Press this button to turn on or off the interior reading lights.



Inside Mood Lighting

Press this button to turn on the Mood Lights behind the heaters. Continue pressing to change the colors.



Red Light Therapy

Press this button to turn on and off the Red Light/Near Infrared LED Light therapy in the ceiling.



Reservation

You can preset your sauna to turn on up to 36 hours in the future:

1. Press the POWER button to turn on your sauna.
2. Press the RESERVE button.
3. The time and temperature will begin to flash.
4. Press the TIME UP button to set the number of hours ahead you would like your sauna to turn on.
5. The range is 1 - 36.
6. Set the maximum set temperature by pressing the TEMP UP or TEMP DOWN button.
7. The keypad will flash and the time will count down in one hour increments until the sauna turns on.
8. To cancel the reservation, press the "POWER" button once to turn off the sauna.



Aux

The AUX button will be used to control additional features that can be added to your sauna.



The instructions to use these features will be included when the item is purchased.

Toggle Switch

Using Your Sauna Control Panel

Using Your Infrared Sauna

Keypad Lock

The keypad can be locked to prevent it from being turned on or off or the temperature adjusted. There are two locking functions:

1. Lock Entire Keypad: Hold the “Inside” button for 5 seconds to lock the keypad. Once it’s locked, hold the “Inside” button for 5 seconds to unlock the keypad.
2. Lock Keypad - Light Button Will Continue To Work: Hold down the mood light button for 5 seconds. This will lock the entire keypad except for the light buttons. To unlock the keypad, repeat the step above.



Note: With the keypad locked, the time will continue to count down and the sauna will turn off when the time is expired.

Audio System

Your Jacuzzi® sauna is equipped with stereo speakers that can be accessed by either Bluetooth® or Aux cable.

1. Your Jacuzzi® Sauna is Bluetooth® ready. To connect audio via Bluetooth®:
 - A) Open your Bluetooth® enabled phone, tablet or computer and search for surrounding Bluetooth® devices to find a device called Infrared Sauna. The pairing code for this device is 0000.
2. There is a 3.5mm jack in the charging compartment that is connected to the speakers in your sauna. You can connect any audio to the speakers using this connection.

Using Your Sauna Control Panel

Using Your Infrared Sauna

Chromotherapy

Color light therapy can benefit your well being. Chromotherapy or Color Light Therapy is the science that uses the seven colors of the light spectrum. Different colors have different wavelengths and can help balance energy for the mind and body. Color has a profound effect on us on all levels, physical, mental, emotional and spiritual.

The chromotherapy light is controlled by either touching the metal plate on the side of the chromotherapy unit or by pressing the buttons on the included remote control.

1. Press the "POWER" button to turn on the Chromotherapy light.
2. Press the "MANUAL" button to manually select a color.
3. Press the "AUTO" button and the Chromotherapy light will automatically change through the various colors.
4. Press the "INTENSITY" up or down buttons to control the brightness of the Chromotherapy light.

The available color in the Chromotherapy light have been specifically selected based on their wavelength:

- 1) Red
- 2) Strong Green
- 3) Strong Blue
- 4) Orange
- 5) Green
- 6) Blue
- 7) Strong Yellow
- 8) Strong Indigo
- 9) Strong Pink
- 10) Yellow
- 11) Indigo
- 12) Violet

A black toggle switch under the control panel is used to turn the exterior ambient lights on and off.

Tips for Use

1. Opening the roof vent and/or door allows fresh air to enter the sauna.
2. Drink water prior to and after your session.
3. Towel off during your session. This will help the body perspire more freely.
4. To relieve sore and tight muscles massage these areas for faster healing and effectiveness
5. Oil and lotions tend to decrease perspiration by blocking pores. Apply these after your session for best results.
6. Some minerals can be lost in perspiration. Eating a sensible diet including fruits and green leafy vegetables will replace these. Supplements can also be taken to replenish minerals.
7. Limit food intake an hour before your sauna session. Your body will not be using energy for digestion.
8. Taking a shower or bath before a sauna session tends to increase perspiration as bathing opens the pores.
9. As you become more heat conditioned, you may wish to increase the length of your Jacuzzi® sauna session to 40 minutes. (Make sure to drink water throughout your sauna session.)

Tips for Use

10. If you notice any drying of your skin with ongoing use of your Jacuzzi® sauna, it is suggested that you increase your consumption of the best quality oil available (i.e. expeller pressed oil such as Organic Canola Oil or Organic Coconut Oil are very good). Add 2-4 tablespoons a day to your diet. The essential oils in these products are useful for skin health.
11. Unlike a traditional sauna, infrared heats the body directly. Air temperature in the sauna is not as important as the type and quality of the infrared being received. We recommend the following protocol:
 - a. Turn the sauna on for 10-15 minutes to allow the heaters to come up to optimal temperature and for the cabin to warm to a comfortable temperature.
 - b. When you enter the sauna, set the time to the desired session time and turn the thermostat up to 158 degrees. This will keep the heaters on the entire time to ensure that you are receiving constant infrared heat. During a 30 minute sauna session, the air temperature will reach between 115-125F.
 - c. Sit back and relax. Enjoy your sauna session.

We hope you enjoy years of relaxation and better health from regular use of your Jacuzzi® sauna.

If you have any question on the proper use of your sauna, please call us at 800.798.1779 or +1.510.601.1775.

Safety Instructions

1. Read and follow all instructions carefully.
2. When installing and using this electrical equipment, basic safety precautions should always be followed.
3. To reduce the risk of injury, do not allow children to use the sauna unless they are closely supervised at all times.
4. Do not use the sauna immediately following strenuous exercise. Wait at least 15 minutes to allow the body to cool down completely.
5. Excessive temperatures have a high potential for causing fetal damage during the early months of pregnancy. Pregnant or possibly pregnant women should contact their physician prior to using the sauna.
6. **Hyperthermia Danger:** Prolonged exposure to hot air will induce hyperthermia. Hyperthermia occurs when the internal temperature of the body reaches a level several degrees above the normal body temperature of 98.6F (37C). While hyperthermia has many health benefits, it is important not to allow your body's core temperature to rise above 103F (39.5C). Symptoms of excessive hyperthermia include dizziness, lethargy, drowsiness, and fainting. The effects of excessive hyperthermia may include failure to perceive heat, failure to recognize the need to exit, unawareness of impending hazard, fetal damage in pregnant women, physical inability to exit the sauna, and unconsciousness.
7. The use of alcohol, drugs, or medications prior to or during the sauna session may lead to unconsciousness.
8. Persons suffering from obesity or with a medical history of heart disease, low or high blood pressure, circulatory system problems, or diabetes should consult a physician prior to using the sauna.
9. Persons using medications should consult a physician before using the sauna since some medications may induce drowsiness while others may affect heart rate, blood pressure, and circulation.

Safety Instructions

10. Exercise care when entering or exiting the sauna.
11. Never sleep inside the sauna while the unit is in full operation.
12. Do not use any type of cleaning agents on the interior of the sauna.
13. Do not stack or store any objects on top of or inside the sauna.
14. If the power supply cord becomes damaged, it must immediately be replaced by the manufacturer or its agent or a similarly qualified person to avoid a hazard.
15. Do not use the unit during an electrical storm, as there is a remote risk of shock.
16. Altering or tampering of any electrical connections on the power supply will void the manufacturer's warranty.
17. Dry your hands before handling electrical controls. Never unplug the power cord or adjust the controls with wet hands or when you have wet bare feet. A danger of electrical shock exists.
18. Do not attempt any repair without consulting the manufacturer first. Unauthorized repair attempts will void manufacturer's warranty.
19. We strongly recommend the use of a GROUND FAULT CIRCUIT INTERRUPTER (GFCI) device in any potentially wet locations.
20. Your Jacuzzi® sauna is made of the finest Mahogany. All wood products have variations in the color, grain, and may have irregularities such as knots, and fine cracks. These reflect the natural beauty of the wood and should not be considered defects.
21. To safeguard against burns, do not touch heaters or lamps directly.

Important Safeguards

Important Safeguards

1. **READ INSTRUCTIONS** - All safety and operating instructions should be read before the sauna is installed & operated.
2. **RETAIN INSTRUCTIONS** - The safety and operating instructions should be retained for future reference.
3. **HEED WARNINGS** - All warnings on the sauna should be adhered to.
4. **FOLLOW INSTRUCTIONS** - All operating and usage instructions should be followed at all times.
5. **ATTACHMENTS** - Do not use attachments that are not recommended by the manufacturer as they may cause hazard.
6. **WATER OR MOISTURE** - Use precaution if the sauna is used near a shower room..
7. **GROUNDING OR POLARIZATION** - This sauna is intended for use with a 3-wire properly grounded power socket Do not defeat the safety purpose of the supplied line cord and plug.
8. **POWER SOURCES** - This product should be operated only from the required type of power source indicated on the marking label. If you are not sure of the type of power supplied to your home, consult your local power company.
9. **POWER-CORD PROTECTION** - Power supply cords should be routed so they are not likely to be walked on or pinched.
10. **LIGHTNING** - For added protection for this product during a lightning storm, or when it is left unattended and unused for long periods of time, unplug it from the wall outlet.
11. **OVERLOADING** - Do not overload wall outlets and extension cords as this can result in a risk of fire or electrical shock.

Important Safeguards

Important Safeguards

12. **SERVICING** - Always unplug this product from the wall outlet before servicing the product.
13. **POWER SUPPLY** - Do not remove power supply covers. No user-serviceable parts are located inside the power supply.
14. **REPLACEMENT PARTS** - When replacement parts are required, only use parts specified by the manufacturer. Unauthorized substitutes could result in fire, electrical shock or other hazards.
15. **SAFETY CHECK** - Upon completion of any service or repairs to this product by a service technician, ask the technician to perform safety checks make certain that the product is in proper operating condition.

